

09















SEW-ON ARTICLES

Sew-on Articles are loose crystals that can be easily sewn either by hand, or with a standard domestic or industrial embroidery sewing machine onto any kind of textile or accessory. Sew-on Articles come in two- or three-hole varieties, including round, oval, and triangle holes for use in a wide range of decorative applications, from fine embroidery or to jewelry. Lochrosen are crystals with just one hole. Sew-on Articles have rounded edges on the hole entry and exit areas to guarantee thread protection. The assortment offers a great variety of colors and effects to transform textiles and fashion accessories into bespoke luxury items.

The most important items in this product group are art. 3188 XIRIUS Lochrose and art. 3288 XIRIUS Sew-on Stone, featuring the most progressive and unique cut on the market: multilayer cut technology, creating the inspiring XIRIUS star design.

SEW-ON ARTICLES

COLORS

-  **Crystal**
001
-  **Light Silk**
261
-  **Light Peach**
362
-  **Blush Rose**
257
-  **Light Siam**
227
-  **Fuchsia**
502
-  **Smoky Mauve**
265
-  **Light Turquoise**
263
-  **Denim Blue**
266
-  **Black Diamond**
215
-  **Peridot**
214
-  **Fern Green**
291
-  **Emerald**
205
-  **Light Colorado Topaz**
246
-  **Yellow Opal**
231
-  **Tangerine**
259
-  **Graphite**
253
-  **Jet**
280

EFFECTS

-  **Crystal Silver Shade**
001 SSHA
-  **Crystal Moonlight**
001 MOL
-  **Crystal Aurore Boreale**
001 AB
-  **Crystal Luminous Green**
001 LUMG
-  **Crystal Golden Shadow**
001 GSHA
-  **Crystal Metallic Sunshine**
001 METSH
-  **Crystal Rose Gold**
001 ROGL
-  **Crystal Astral Pink**
001 API
-  **Crystal Paradise Shine**
001 PARSH
-  **Crystal Vitrail Medium**
001 VM
-  **Crystal Lilac Shadow**
001 LISH
-  **Crystal Blue Shade**
001 BLSH
-  **Crystal Scarabaeus Green*****
001 SCGR
-  **Crystal Rainbow Dark**
001 RABDK
-  **Crystal Iridescent Green**
001 IRIG
-  **Crystal Satin**
001 SAT
-  **Crystal Light Chrome**
001 LTCH
-  **Crystal Silver Night**
001 SINI
-  **Jet Hematite**
280 HEM

CRYSTAL PATINA

-  **Crystal White Patina**
001 WHIPA
-  **Crystal Rose Patina**
001 ROSPA
-  **Crystal Silver Patina**
001 SILPA
-  **Crystal Gold Patina**
001 GOLPA
-  **Crystal Black Patina**
001 BLAPA

For details on available colors and effects for each article within the product groups, please see the product matrix of the respective item in the Collection 2016. For color and effect samples, please see the corresponding color chart.

Classic Colors/Effects:

This color range offers a wide choice of traditional Swarovski crystal colors and effects.

Exclusive Colors/Effects:

This color range is offered exclusively by Swarovski.

*** designed by Jean Paul Gaultier

Colors and effects can appear different when illuminated with different light sources. Swarovski uses standard light source D50 for color decision and comparison. Slight changes in shades are unavoidable. Colors may vary according to cut and foiling.

The composition of Advanced Crystal is compliant with regulatory industry norms and laws regarding the restriction or prohibition of certain substances in the most relevant segments of our customers. Please note that the compliance of the crystal colors Citrine, Fireopal, Hyacinth, Light Siam, Siam and Yellow Opal vary to certain industry regulations. Those regulations are indicated with an (*) in the compliance overview. Indian Siam (option to Lt. Siam) and Tangerine (option to Sun) conform to all CLEAR-lists.

For further information please visit swarovski.com/professional

© 2016 D. Swarovski Distribution GmbH

SEW-ON ARTICLES

NUMERICAL ORDER

001 Crystal
 001 AB Crystal Aurore Boreale
 001 API Crystal Astral Pink
 001 BLAPA Crystal Black Patina
 001 BLSH Crystal Blue Shade
 001 GOLPA Crystal Gold Patina
 001 GSHA Crystal Golden Shadow
 001 IRIG Crystal Iridescent Green
 001 LISH Crystal Lilac Shadow
 001 LTCH Crystal Light Chrome
 001 LUMG Crystal Luminous Green
 001 METSH Crystal Metallic Sunshine
 001 MOL Crystal Moonlight
 001 PARSH Crystal Paradise Shine
 001 RABDK Crystal Rainbow Dark
 001 ROGL Crystal Rose Gold
 001 ROSPA Crystal Rose Patina
 001 SAT Crystal Satin
 001 SCGR Crystal Scarabaeus Green***
 001 SILPA Crystal Silver Patina
 001 SINI Crystal Silver Night
 001 SSHA Crystal Silver Shade
 001 VM Crystal Vitrail Medium
 001 WHIPA Crystal White Patina
 205 Emerald
 214 Peridot
 215 Black Diamond
 227 Light Siam
 231 Yellow Opal
 246 Light Colorado Topaz
 253 Graphite
 257 Blush Rose
 259 Tangerine
 261 Light Silk
 263 Light Turquoise
 265 Smoky Mauve
 266 Denim Blue
 280 Jet
 280 HEM Jet Hematite
 291 Fern Green
 362 Light Peach
 502 Fuchsia



















































ALPHABETICAL ORDER

Black Diamond (215)
Blush Rose (257)
 Crystal (001)
Crystal Astral Pink (001 API)
Crystal Aurore Boreale (001 AB)
Crystal Black Patina (001 BLAPA)
Crystal Blue Shade (001 BLSH)
Crystal Gold Patina (001 GOLPA)
Crystal Golden Shadow (001 GSHA)
Crystal Iridescent Green (001 IRIG)
Crystal Light Chrome (001 LTCH)
Crystal Lilac Shadow (001 LISH)
Crystal Luminous Green (001 LUMG)
Crystal Metallic Sunshine (001 METSH)
Crystal Moonlight (001 MOL)
Crystal Paradise Shine (001 PARSH)
Crystal Rainbow Dark (001 RABDK)
Crystal Rose Gold (001 ROGL)
Crystal Rose Patina (001 ROSPA)
Crystal Satin (001 SAT)
Crystal Scarabaeus Green*** (001 SCGR)
Crystal Silver Night (001 SINI)
Crystal Silver Patina (001 SILPA)
Crystal Silver Shade (001 SSHA)
Crystal Vitrail Medium (001 VM)
Crystal White Patina (001 WHIPA)
Denim Blue (266)
 Emerald (205)
Fern Green (291)
 Fuchsia (502)
Graphite (253)
 Jet (280)
 Jet Hematite (280 HEM)
 Light Colorado Topaz (246)
 Light Peach (362)
 Light Siam (227)
 Light Silk (261)
 Light Turquoise (263)
 Peridot (214)
Smoky Mauve (265)
Tangerine (259)
Yellow Opal (231)

*** designed by Jean Paul Gaultier

SEW-ON ARTICLES

SUMMARY

- | | | | | | |
|--|--|--|--|--|------------------------------------|
| 1
 | 2
 | 3129
7 mm | 1
 | 2
 | 3255
18x6, 26x8.5 mm |
|  |  | 3188
3, 4, 5, 6, 7, 8 mm |  |  | 3256
14x8.5, 19x11.5 mm |
|  |  | 3200
10, 12, 14, 16, 18 mm |  |  | 3258
12x8.5, 16x11.5 mm |
|  |  | 3201
10, 12, 14 mm |  |  | 3259
12, 16 mm |
|  |  | 3210
10x7, 16x11, 24x17 mm |  |  | 3261
18, 28 mm |
|  |  | 3220
10, 14 mm |  |  | 3265
20x16, 26x21 mm |
|  |  | 3221
18 mm |  |  | 3267
18x10 mm |
|  |  | 3223
12x6, 18x9 mm |  |  | 3270
16, 22 mm |
|  |  | 3230
12x7, 18x10.5,
28x17 mm |  |  | 3288
8, 10, 12 mm |
|  |  | 3231
18x11, 23x14 mm |  |  | 3293
12 mm |
|  |  | 3240
16, 22 mm |  |  | 3400
6, 8 mm |
|  |  | 3250
18x13 mm |  |  | 3700
6, 8, 10, 12, 14 mm |
|  |  | DESIGNER EDITION
3254
20x9, 30x14 mm | | | |

1 Top view 2 Side view

SEW-ON ARTICLES

3129

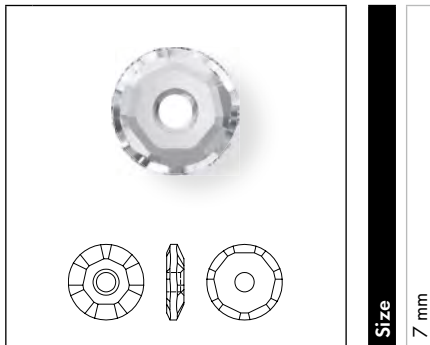

- Crystal**
- Crystal (001)
- Colors**
- Plain Colors**
- Black Diamond (215)
- Jet (280)
- Crystal Effects**
- Transparent Effects**
- Crystal AB (001 AB)
- Color Effects**
- Metallic Effects**
- Jet Hematite (280 HEM)

3188 XIRIUS Lochrose

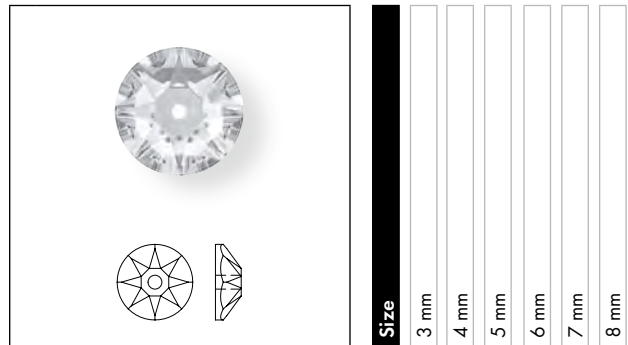

- Crystal**
- Crystal (001)
- Crystal F (001)
- Colors**
- Plain Colors**
- Black Diamond F (215)
- Blush Rose F (257)
- Denim Blue F (266)
- Emerald F (205)
- Fuchsia F (502)
- Graphite F (253)
- Jet (280)
- Light Colorado Topaz F (246)
- Light Peach F (362)
- Light Siam F (227)
- Light Silk F (261)
- Smoky Mauve F (265)
- Tangerine F (259)
- Crystal Effects**
- Transparent Effects**
- Crystal AB F (001 AB)
- Crystal Astral Pink F (001 API)
- Crystal Blue Shade F (001 BLSH)
- Crystal Golden Shadow F (001 GSHA)
- Crystal Lilac Shadow F (001 LISH)
- Crystal Luminous Green F (001 LUMG)
- Crystal Moonlight F (001 MOL)
- Crystal Paradise Shine F (001 PARSH)
- Crystal Silver Night (001 SINI)
- Crystal Silver Shade F (001 SSHA)
- Metallic Effects**
- Crystal Iridescent Green F (001 IRIG)
- Crystal Light Chrome F (001 LTCH)
- Crystal Metallic Sunshine F (001 METSH)
- Crystal Scarabaeus Green***F (001 SCGR)
- Color Effects**
- Metallic Effects**
- Jet Hematite (280 HEM)

*** designed by Jean Paul Gaultier

SEW-ON ARTICLES

3200 Rivoli Sew-on Stone

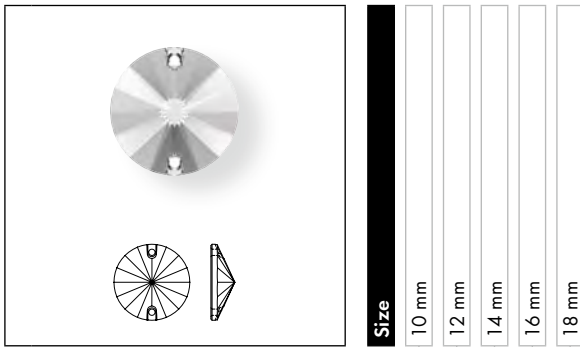

Size
10 mm
12 mm
14 mm
16 mm
18 mm

Crystal	10 mm	12 mm	14 mm	16 mm	18 mm
Crystal F (001)	■	■	■	■	■
Colors					
Plain Colors					
Black Diamond F (215)	■	■	■		
Blush Rose F (257)	■	■	■		
Fuchsia F (502)	■	■	■		
Graphite F (253)	■	■	■		
Jet (280)	■	■	■		
Light Colorado Topaz F (246)	■	■			
Light Rose F (223)	■				
Light Siam F (227)	■	■	■		
Light Turquoise F (263)	■				
Smoky Mauve F (265)	■	■	■		
Opal Colors					
Yellow Opal F (231)	■				
Crystal Effects					
Transparent Effects					
Crystal AB F (001 AB)	■	■	■	■	■
Crystal Golden Shadow F (001 GSHA)	■	■			
Crystal Paradise Shine F (001 PARSH)	■	■	■		
Crystal Satin F (001 SAT)	■	■			
Metallic Effects					
Crystal Iridescent Green F (001 IRIG)	■	■	■		
Crystal Metallic Sunshine F (001 METSH)	■	■	■		
Crystal Scarabaeus Green***F (001 SCGR)	■	■	■		
Color Effects					
Metallic Effects					
Jet Hematite (280 HEM)	■	■	■		

3201 Rivoli Square Sew-on Stone

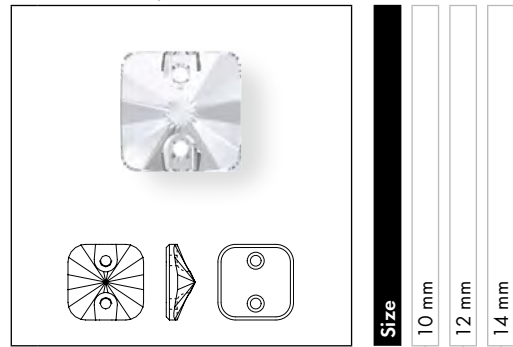

Size
10 mm
12 mm
14 mm

Crystal	10 mm	12 mm	14 mm
Crystal F (001)	■	■	■
Colors			
Plain Colors			
Blush Rose F (257)	■	■	■
Denim Blue F (266)	■	■	■
Jet (280)	■	■	■
Light Colorado Topaz F (246)	■	■	■
Light Siam F (227)	■	■	
Crystal Effects			
Transparent Effects			
Crystal AB F (001 AB)	■	■	■
Crystal Golden Shadow F (001 GSHA)	■	■	■
Crystal Luminous Green F (001 LUMG)	■	■	■
Crystal Silver Night (001 SINI)	■	■	■
Crystal Effects			
Metallic Effects			
Crystal Iridescent Green F (001 IRIG)	■	■	■
Crystal Metallic Sunshine F (001 METSH)	■	■	■
Crystal Rose Gold F (001 ROGL)	■	■	■

*** designed by Jean Paul Gaultier

SEW-ON ARTICLES

3210 Oval Sew-on Stone



Size
10x7 mm
16x11 mm
24x17 mm

Crystal	10x7 mm	16x11 mm	24x17 mm
Crystal F (001)	■	■	■
Colors			
Plain Colors			
Light Colorado Topaz F (246)	■		
Crystal Effects			
Transparent Effects			
Crystal AB F (001 AB)	■	■	■
Crystal Silver Night (001 SINI)	■	■	■
Metallic Effects			
Crystal Light Chrome F (001 ITCH)	■	■	■
Crystal Metallic Sunshine F (001 METSH)	■	■	■
Crystal Patina Effects			
Crystal Black Patina F (001 BLAPA)	■	■	■
Crystal Gold Patina F (001 GOLPA)	■	■	■
Crystal Rose Patina F (001 ROSPA)	■	■	■
Crystal Silver Patina F (001 SILPA)	■	■	■
Crystal White Patina F (001 WHIPA)	■	■	■

3220 Round Chessboard Sew-on Stone

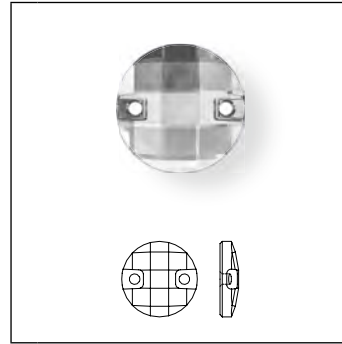

Size
10 mm
14 mm

Crystal	10 mm	14 mm
Crystal F (001)	■	■
Crystal Effects		
Transparent Effects		
Crystal AB F (001 AB)	■	■
Crystal Golden Shadow F (001 GSHA)	■	■
Metallic Effects		
Crystal Iridescent Green F (001 IRIG)	■	■
Crystal Patina Effects		
Crystal Black Patina F (001 BLAPA)	■	■
Crystal Gold Patina F (001 GOLPA)	■	■
Crystal Rose Patina F (001 ROSPA)	■	■
Crystal Silver Patina F (001 SILPA)	■	■
Crystal White Patina F (001 WHIPA)	■	■

SEW-ON ARTICLES

3221 Twist Sew-on Stone

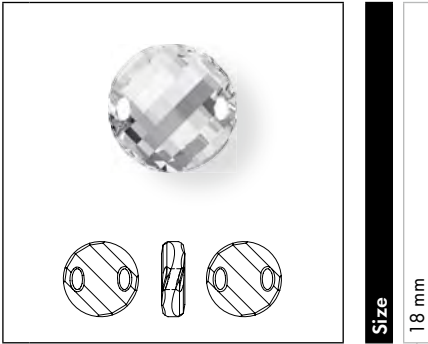

Size

18 mm

Crystal

Crystal F (001)

Crystal Effects

Transparent Effects

Crystal Golden Shadow (001 GSHA)

3223 Navette Sew-on Stone

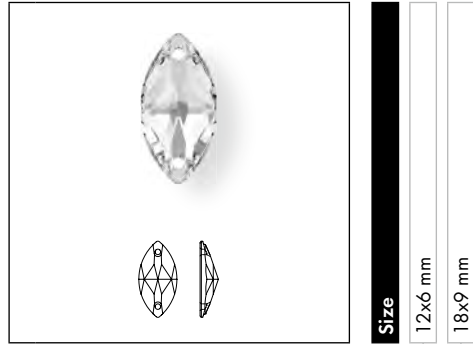

Size

12x6 mm

18x9 mm

Crystal

Crystal F (001)

Colors

Plain Colors

Jet (280)

Crystal Effects

Transparent Effects

Crystal AB F (001 AB)

Crystal Golden Shadow F (001 GSHA)

SEW-ON ARTICLES

3230 Drop Sew-on Stone

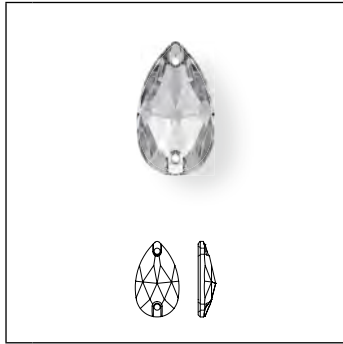

Size	12x7 mm	18x10.5 mm	28x17 mm
------	---------	------------	----------

Crystal

Crystal F (001)	■	■	■
-----------------	---	---	---

Colors

Plain Colors

Fuchsia F (502)	■		
Graphite F (253)	■	■	■
Jet (280)	■		
Light Amethyst F (212)	■		
Light Colorado Topaz F (246)	■		
Light Sapphire F (211)	■		
Light Siam F (227)	■		
Light Turquoise F (263)	■	■	■
Rosaline F (508)	■	■	

Crystal Effects

Transparent Effects

Crystal AB F (001 AB)	■	■	■
Crystal Astral Pink F (001 API)	■	■	■
Crystal Blue Shade F (001 BLSH)	■		
Crystal Copper F (001 COP)	■		
Crystal Golden Shadow F (001 GSHA)	■	■	■
Crystal Luminous Green F (001 LUMG)	■		
Crystal Satin F (001 SAT)	■	■	■
Crystal Silver Night (001 SINI)	■	■	■

Metallic Effects

Crystal Light Chrome F (001 LTCH)	■	■	■
Crystal Rainbow Dark F (001 RABDK)	■	■	■

3231 Owllet Sew-on Stone

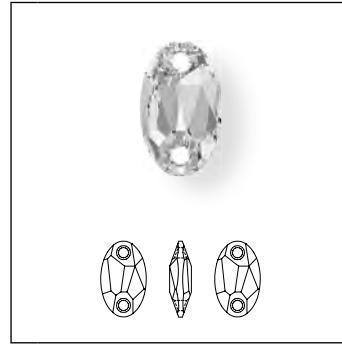

Size	18x11 mm	23x14 mm
------	----------	----------

Crystal

Crystal (001)	■	
---------------	---	--

Crystal F (001)	■	■
-----------------	---	---

Crystal Effects

Transparent Effects

Crystal Golden Shadow (001 GSHA)	■	■
----------------------------------	---	---

SEW-ON ARTICLES

3240 Square Sew-on Stone

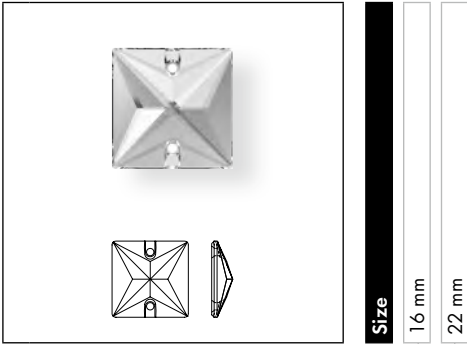

Size

16 mm

22 mm

Crystal

Crystal F (001)

Colors

Plain Colors

Jet (280)

Crystal Effects

Transparent Effects

Crystal AB F (001 AB)

Color Effects

Metallic Effects

Jet Hematite (280 HEM)

3250 Rectangle Sew-on Stone

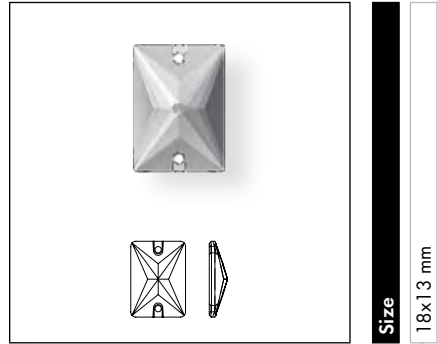

Size

18x13 mm

Crystal

Crystal F (001)

Crystal Effects

Transparent Effects

Crystal AB F (001 AB)

DIAMOND LEAF ¹

Swarovski and Giorgio Armani worked together to create an exclusive crystal called "Diamond Leaf". This Designer Edition has a fluid, organic shape reminiscent of a leaf. Precision cut facets melt into the softness of a floating, sculptural form, contrasting strength and fragility, the timeless with the ethereal.

Giorgio Armani: "Swarovski crystal brings a touch of magic to a dress, an ethereal quality, a lustre which never fails to captivate the attention."

3254 Diamond Leaf Sew-on Stone ¹

Crystal

- Crystal F (001)

Colors

Plain Colors



- Jet (280)

Crystal Effects

Transparent Effects

- Crystal Golden Shadow F (001 GSHA)
- Crystal Silver Shade F (001 SSHA)

THE DIAMOND LEAF DESIGNER EDITION FAMILY

- 
2797 8x4, 10x5 mm chapter 07 Flat Back No Hotfix p. 367
- 
2797 8x4 mm chapter 08 Flat Back Hotfix p. 403
- 
3254 20x9, 30x14 mm chapter 09 Sew-on Articles p. 421

DESIGNER EDITIONS - DISTINCT PACKAGING

This Designer Edition will be labelled with the "Designer Edition" imprint directly on the packaging.

¹ Article consists of Advanced Crystal

SEW-ON ARTICLES

3255 Cosmic Baguette Sew-on Stone

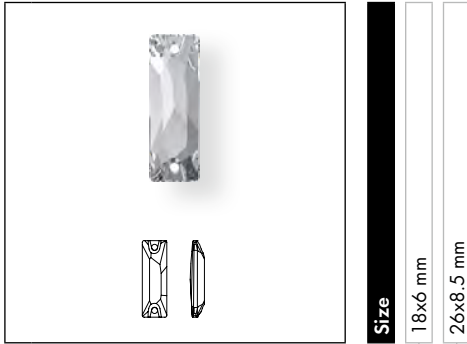

Size
18x6 mm
26x8.5 mm

- Crystal**
- Crystal F (001)
- Colors**
- Plain Colors**
- Jet (280)
- Crystal Effects**
- Transparent Effects**
- Crystal Golden Shadow F (001 GSHA)
- Crystal Silver Shade F (001 SSHA)

3256 Galactic Sew-on Stone

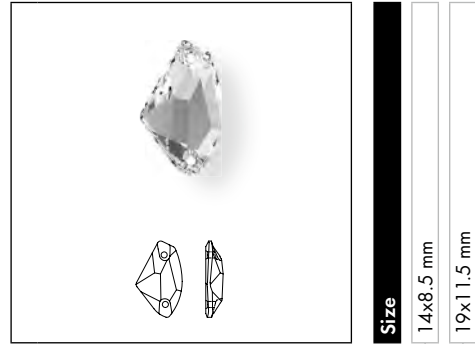

Size
14x8.5 mm
19x11.5 mm

- Crystal**
- Crystal F (001)
- Colors**
- Plain Colors**
- Jet (280)
- Crystal Effects**
- Transparent Effects**
- Crystal Golden Shadow F (001 GSHA)

3258 Bow Tie Sew-on Stone



Size
12x8.5 mm
16x11.5 mm

- Crystal**
- Crystal F (001)
- Colors**
- Plain Colors**
- Denim Blue F (266)
- Jet (280)
- Light Amethyst F (212)
- Light Siam F (227)
- Vintage Rose F (319)
- Crystal Effects**
- Transparent Effects**
- Crystal AB F (001 AB)
- Crystal Golden Shadow F (001 GSHA)
- Crystal Paradise Shine F (001 PARSH)
- Crystal Silver Night (001 SINI)
- Metallic Effects**
- Crystal Iridescent Green F (001 IRIG)

SEW-ON ARTICLES

3259 Heart Sew-on Stone

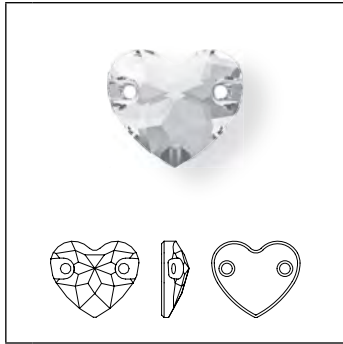

Size	12 mm	16 mm
	12 mm	16 mm
	12 mm	16 mm

Crystal

Crystal F (001)

Colors

Plain Colors

Denim Blue F (266)

Fuchsia F (502)

Jet (280)

Light Siam F (227)

Light Silk F (261)

Smoky Mauve F (265)

Vintage Rose F (319)

Opal Colors

White Opal F (234)

Crystal Effects

Transparent Effects

Crystal AB F (001 AB)

Crystal Golden Shadow F (001 GSHA)

Crystal Lilac Shadow F (001 LISH)

Crystal Paradise Shine F (001 PARSH)

Crystal Silver Night (001 SINI)

Metallic Effects

Crystal Rose Gold F (001 ROGL)

3261 Hexagon Sew-on Stone

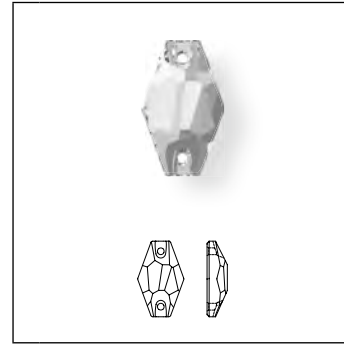

Size	18 mm	28 mm
	18 mm	28 mm
	18 mm	28 mm

Crystal

Crystal F (001)

SEW-ON ARTICLES

3265 Cosmic Sew-on Stone

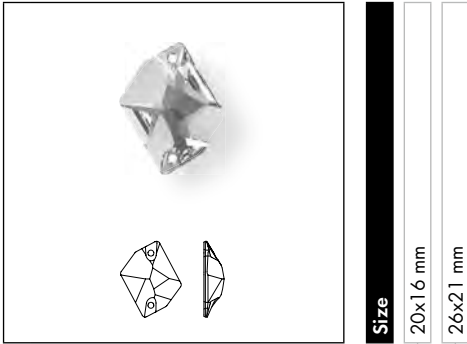

Size

20x16 mm

26x21 mm

Crystal

Crystal F (001)

Colors

Plain Colors

Jet (280)

Crystal Effects

Transparent Effects

Crystal AB F (001 AB)

Crystal Golden Shadow F (001 GSHA)

3267 De-Art Sew-on Stone

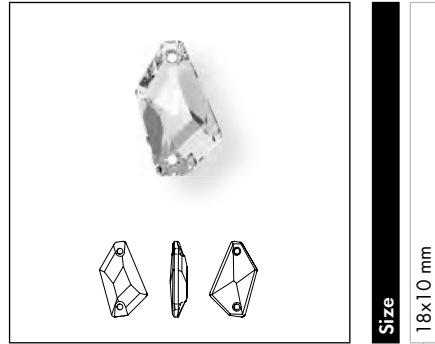

Size

18x10 mm

Crystal

Crystal F (001)

3270 Triangle Sew-on Stone

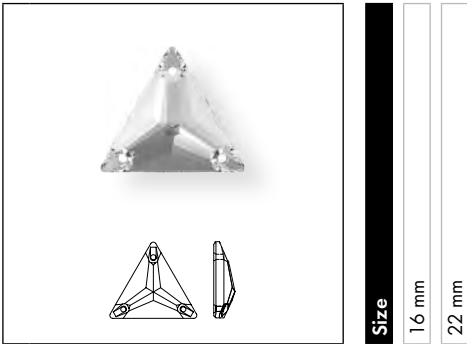

Size

16 mm

22 mm

Crystal

Crystal F (001)

Colors

Plain Colors

Jet (280)

Crystal Effects

Transparent Effects

Crystal AB F (001 AB)

SEW-ON ARTICLES

3288 XIRIUS Sew-on Stone

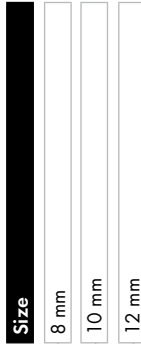
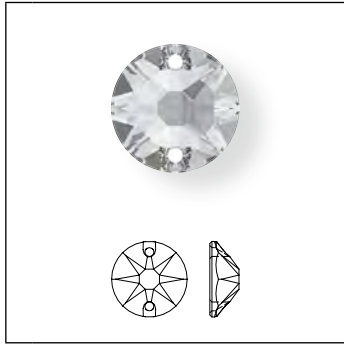

Crystal

Crystal F (001)

Colors

Plain Colors

Black Diamond F (215)

Blush Rose F (257)

Denim Blue F (266)

Emerald F (205)

Fuchsia F (502)

Graphite F (253)

Jet (280)

Light Colorado Topaz F (246)

Light Peach F (362)

Light Siam F (227)

Smoky Mauve F (265)

Tangerine F (259)

Opal Colors

Yellow Opal F (231)

Crystal Effects

Transparent Effects

Crystal AB F (001 AB)

Crystal Astral Pink F (001 API)

Crystal Blue Shade F (001 BLSH)

Crystal Golden Shadow F (001 GSHA)

Crystal Lilac Shadow F (001 LISH)

Crystal Luminous Green F (001 LUMG)

Crystal Moonlight F (001 MOL)

Crystal Paradise Shine F (001 PARSH)

Crystal Silver Night (001 SINI)

Crystal Silver Shade F (001 SSHA)

Metallic Effects

Crystal Iridescent Green F (001 IRIG)

Crystal Light Chrome F (001 LTCH)

Crystal Metallic Sunshine F (001 METSH)

Crystal Scarabaeus Green*** F (001 SCGR)

Color Effects

Metallic Effects

Jet Hematite (280 HEM)

3293 Chessboard Sew-on Stone

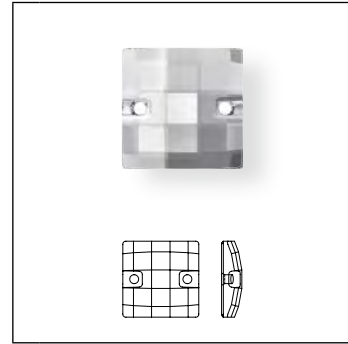

Crystal

Crystal F (001)

*** designed by Jean Paul Gaultier

SEW-ON ARTICLES

3400 Square Lochrose

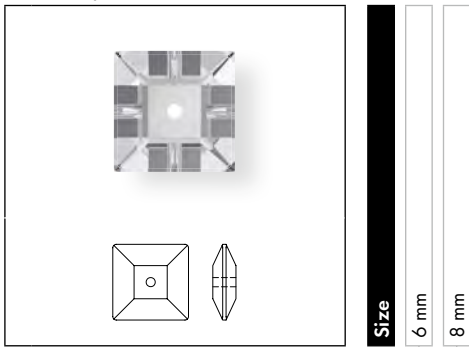

Size
6 mm
8 mm

Crystal	
Crystal F (001)	
Colors	
Plain Colors	
Light Colorado Topaz F (246)	
Crystal Effects	
Transparent Effects	
Crystal AB F (001 AB)	
Crystal Satin F (001 SAT)	

3700 Marguerite Lochrose

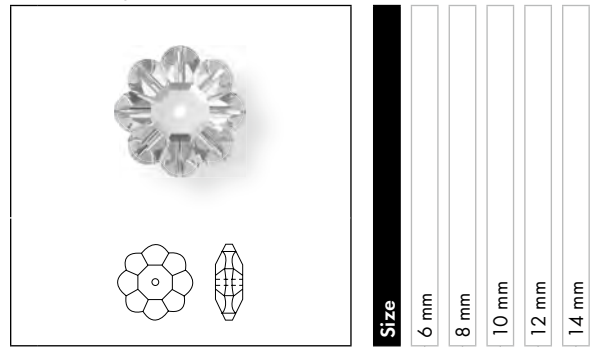

Size
6 mm
8 mm
10 mm
12 mm
14 mm

Crystal	
Crystal (001)	
Crystal F (001)	
Colors	
Plain Colors	
Emerald (205)	
Fern Green (291)	
Peridot (214)	
Crystal Effects	
Transparent Effects	
Crystal AB (001 AB)	
Crystal Vitrail Medium (001 VM)	

SEW-ON ARTICLES

PRODUCT DETAILS

Article Size	Packing Unit = Minimum Order Quantity in Pieces	Average Net Weight in Grams per Packing Unit Crystal (001)	Average Gross Weight in Grams per Packing Unit Crystal (001)
3129			
7 mm	2,880	291.3	473.2
3188			
3 mm	1,440	21.5	30.0
4 mm	1,440	47.6	56.0
5 mm	720	43.2	51.7
6 mm	360	35.7	44.1
7 mm	144	22.2	30.7
8 mm	144	33.2	41.7
3200			
10 mm	72	26.1	44.6
12 mm	72	54.9	74.0
14 mm	72	77.2	100.7
16 mm	72	115.8	139.4
18 mm	48	117.2	199.5
3201			
10 mm	144	70.3	89.2
12 mm	72	61.3	86.5
14 mm	72	85.5	115.0
3210			
10x7 mm	72	18.1	37.9
16x11 mm	72	66.3	86.3
24x17 mm	24	72.5	97.9
3220			
10 mm	192	69.4	97.3
14 mm	96	88.7	120.2
3221			
18 mm	72	174.8	198.5
3223			
12x6 mm	48	13.1	34.2
18x9 mm	36	27.7	45.1
3230			
12x7 mm	96	29.7	47.0
18x10.5 mm	72	70.5	90.7
28x17 mm	24	72.1	97.5
3231			
18x11 mm	96	120.5	148.2
23x14 mm	36	96.4	126.9
3240			
16 mm	72	108.5	132.1
22 mm	24	88.0	139.6
3250			
18x13 mm	72	111.5	135.1
3254			
20x9 mm	72	60.3	87.8
30x14 mm	36	100.6	129.6
3255			
18x6 mm	96	64.3	87.1
26x8.5 mm	48	87.6	125.6

SEW-ON ARTICLES

09 SEW-ON ARTICLES

Article Size	Packing Unit = Minimum Order Quantity in Pieces	Average Net Weight in Grams per Packing Unit Crystal (001)	Average Gross Weight in Grams per Packing Unit Crystal (001)
3256			
14x8.5 mm	96	48.2	67.5
19x11.5 mm	96	104.5	140.1
3258			
12x8.5 mm	96	37.1	58.2
16x11.5 mm	48	36.3	57.5
3259			
12 mm	72	53.9	77.7
16 mm	30	52.2	77.6
3261			
18 mm	72	78.3	110.3
28 mm	30	150.7	175.6
3265			
20x16 mm	72	113.5	138.4
26x21 mm	20	59.8	85.0
3267			
18x10 mm	96	96.0	133.0
3270			
16 mm	72	96.4	120.0
22 mm	24	72.3	117.4
3288			
8 mm	144	51.0	61.9
10 mm	72	53.9	80.3
12 mm	72	69.8	96.5
3293			
12 mm	72	72.3	95.7
3400			
6 mm	360	47.5	58.4
8 mm	288	81.1	107.2
3700			
6 mm	720	50.6	61.4
8 mm	288	62.2	88.4
10 mm	288	114.5	141.0
12 mm	144	105.4	128.5
14 mm	144	170.5	197.2

